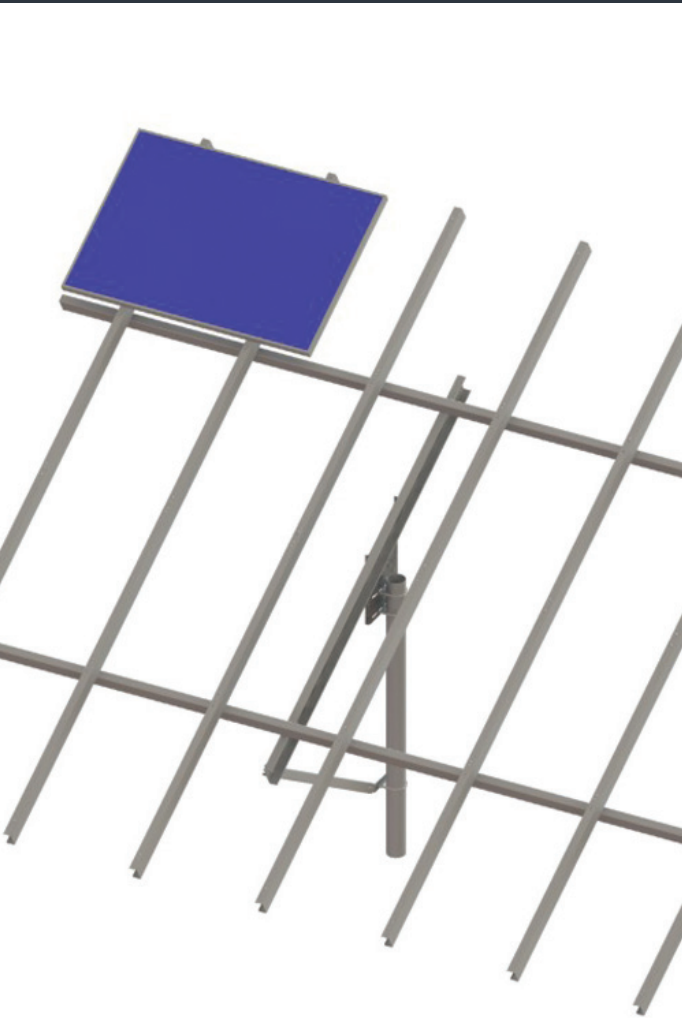


PRU

Utility Scale Ground Mount



Installation Manual

Release, March 2015



TABLE OF CONTENTS

1. INTRODUCTION

pg 1, 2

2. SAFETY CONSIDERATIONS

pg 3

3. PREPARATION

pg 4

4. DUAL-POST FLAT SUPPORT ASSEMBLY

pg 5,6

5. DUAL-POST ROUND SUPPORT ASSEMBLY

pg 7

6. MONO-POST FLAT SUPPORT ASSEMBLY

pg 8

7. MONO-POST ROUND SUPPORT ASSEMBLY

pg 9

8. PURLIN INSTALLATION INSTRUCTIONS

pg 10, 11

9. FOOT BRACKET INSTALLATION INSTRUCTIONS

pg 12

10. PV MODULE INSTALLATION INSTRUCTIONS

pg 13, 14, 15

11. OPTIONAL DUAL-POST FLAT SUPPORT ASSEMBLY

pg 16

12. APPENDICES

pg 17, 18, 19, 20, 21, 22

12. WARRANTY

pg 23

1. INTRODUCTION

1.1 PRODUCT OVERVIEW

As a robust, versatile, long-life, and weather resistant mounting system, the PRU has been designed for a variety of ground mount applications.

The overall design of the PRU has been optimized to provide a low total-life cycle cost solution capable of being installed in a wide range of ground and weather conditions while minimizing environmental impact.

SIMPLE INSTALLATION

The PRU solar racking system is our ground mounted racking solution that is highly configurable, easy to assemble, and cost effective. Additionally, its rigid and modular design improves installation time dramatically by minimizing part complexity.

SERVICE LIFE WARRANTY

Polar Racking provides a standard limited product warranty of 10 years for the service life of all materials used. Additional warranty options are also available.

DURABILITY

The galvanized steel construction provides robust strength and longevity, extending system durability. All components are corrosion-resistant, completely recyclable, and have been designed to meet UL2703 requirements.

SAFETY

If a building permit is required, Polar Racking will design and engineer the mounting system according to an auditable assessment of the statics on request.

1.2 ABOUT THIS MANUAL

SUBJECT

This manual details the installation and assembly of the PRU Ground Mount Utility Racking Systems.

TARGET AUDIENCE

This manual is intended for qualified personnel with a working knowledge of mechanics, hand tools and those who possess mechanical skills.

SIGNPOSTS

The following will assist you in finding your way around in this manual:

HEADERS

The headers display the heading of the current chapter.

FOOTERS

The footers display the product name, the name of the document, and the page number.

TEXT MARKUPS

Labels in the text are printed in **bold**, brand and company names in *italics* and item numbers from the illustrations are depicted in a text box as 1., 2., etc.

OVERVIEW

An overview with legend serves as an orientation aid for the installation and is located in chapter 6 of this installation manual.

ADDITIONAL INFORMATION

Identifies background and additional information for processes.

1. INTRODUCTION CONT'D

1.3 PRODUCT LIABILITY

This technical documentation is part of the product. Polar Racking is not liable for damages resulting from failure to comply with the installation instructions, particularly the safety instructions, as well as misuse of the product.

1.4 STANDARDS COMPLIANCE

The PRU Ground Mount Utility Racking System is tested in accordance with the Ontario Building Code, the International Building Code, the National Building Code of Canada, the ASCE 7-05, and the ASCE 7-10.

1.5 PRODUCT CARE AND MAINTENANCE

MAINTENANCE PERIODS

The maintenance work described below must be performed once every year from the date of installation.

MAINTENANCE REQUIREMENTS

- Inspect all fasteners and component connections once per year. Observe for any deformation, cracks or other visible defects on the PRU components and replace.
- Check bolts on all hardware for specified torque and retighten if required (ensuring solar modules are seated correctly).

2. SAFETY CONSIDERATIONS

2.1 BASIC SAFETY CONSIDERATIONS

The following basic safety instructions and the warning notes are an essential part of this manual and are of fundamental importance for handling the product.

2.2 WARNINGS

Throughout this manual you will notice several warning notes which consist of:

- Warning Symbols
- Indicator Word to dictate the danger Level
- Information regarding the source and type of the danger
- Information about possible consequences if the hazard is not observed
- Measures for avoiding the hazard, and ways to prevent injuries or property damages



DANGER

Denotes a major risk. Failure to observe may lead to serious injury or death.



WARNING

Denotes a potentially dangerous situation. Failure to observe may lead to moderate to severe injury and/or property damage.



CAUTION

Denotes a potential hazard which may lead to physical injury and/or property damage.

2.3 RESPONSIBILITIES OF THE INSTALLER

It is the responsibility of the installer to ensure all applicable safety measures are strictly adhered to while installing this PV Mounting system. Any modifications are to be performed only by authorized personnel and should be approved by Polar Racking prior to implementation. The installer must have adequate skill and knowledge with any materials and tools used to install this system. Furthermore, the installer must be able to recognize any possible dangers, whether they are stated in this manual or not. Every person installing this system must read, and fully understand, every section of this manual prior to working on the system.

2.4 RESPONSIBILITIES OF THE OPERATOR

It is the responsibility of the operator to ensure all scheduled maintenance is performed on time. He/She must ensure that the installation of the system is performed only by qualified personnel with adequate skill and knowledge who are able to meet the responsibilities listed in Chapter 2.2. The operator must ensure a copy of this manual is available to any installer and/or maintenance person as it is part of the system. A replacement manual may be obtained by contacting Polar Racking using the contact information provided on the back of this manual.

3. PREPARATION

3.1 FOUNDATION SYSTEMS

The PRU system is compatible with virtually all foundation types. It is the responsibility of the developer, owner and/or system installer to ensure that the holder of the foundation warranty is aware of the solar installation using the PRU and will continue to honor its warranty. It is the responsibility of the developer, owner, and/or installer to verify that the PRU system is compatible with the foundation design used.

3.2 TOOLS AND MATERIALS

The following tools and materials are required for installation:

- 6mm T Handle Ball End Allen Wrench
- Cordless Drill
- Tape Measure
- String or Twine
- Compass
- Laser Level
- Drill Bits for M8, M12, 3/8", 1/2" bolts and nuts

3.3 SITE PREPARATION

Prior to commencing installation of the PRU system ensure the following:

- All safety preparations have been made in compliance with local regulations and the site owners requirements
- All required tools and materials are available for the installation
- All loose debris and any potential safety hazards have been removed from the site
- The installers have copies of the construction drawings

4. DUAL-POST FLAT SUPPORT ASSEMBLY

STEP 1

Align south leg, north leg, brace, and north-south beam along the same plane. Bolt the brace to the north and south legs using 4 fasteners as shown in Figure 2. Repeat this process to connect the north-south beam to each leg.

STEP 2

Repeat step 2 as needed to assemble all leg supports for tables. Load and ship the supports on flatbed truck or manually to site as necessary.

STEP 3

Attach leg assembly to existing foundation (project dependent, see foundation manual).

Note: Ensure to torque fasteners according to torque tables specified in engineering drawings provided.

4. DUAL-POST FLAT SUPPORT ASSEMBLY CONT'D

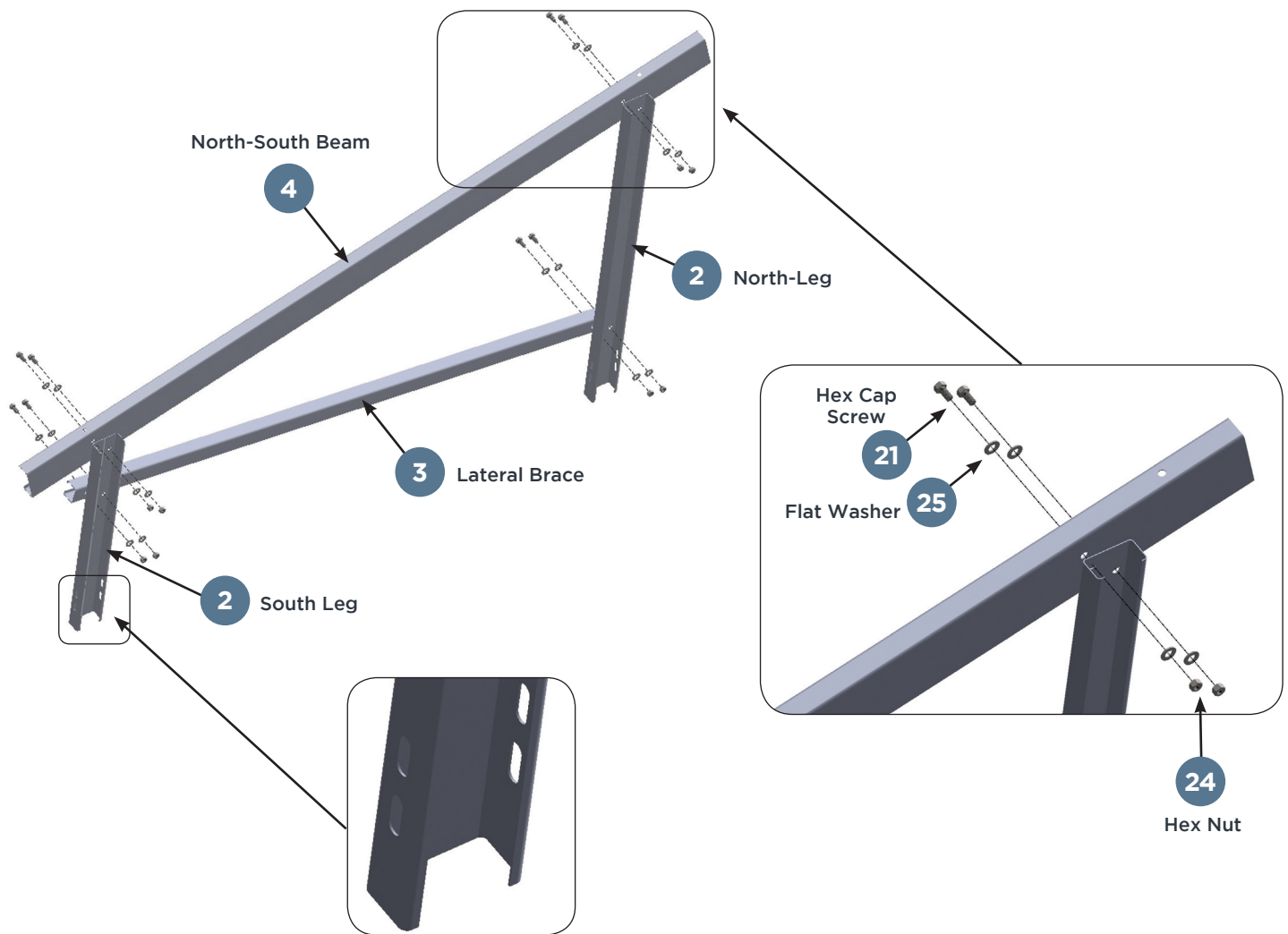


FIGURE 2: DUAL-POST FLAT SUPPORT ASSEMBLY

Note: Ensure to torque fasteners according to torque tables specified in engineering drawings provided.

5. DUAL-POST ROUND SUPPORT ASSEMBLY

STEP 1

Attach round dual-posts to foundation (project dependent, refer to foundation manual).

STEP 2

Fasten the lateral brace to north and south posts using 2 U-bolts (see engineering drawing) as shown in Figure 3.

STEP 3

Secure the north-south beam to the north and south posts in the same manner that the brace was attached using 2 U-bolts as shown.

STEP 4

Repeat the same process to install the remainder of dual-leg supports for the tables.

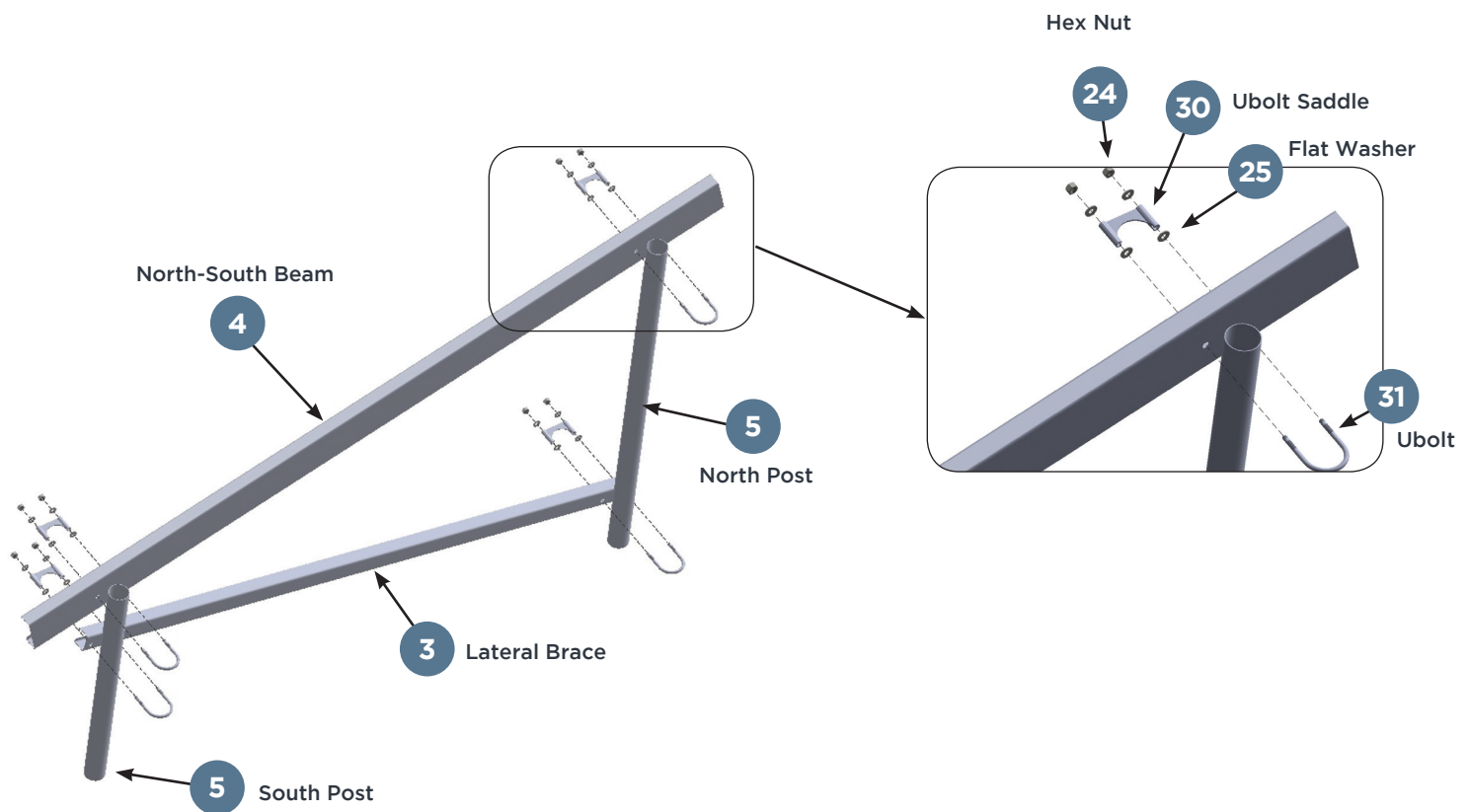


FIGURE 3: DUAL-POST ROUND SUPPORT ASSEMBLY

Note: Ensure to torque fasteners according to torque tables specified in engineering drawings provided.

6. MONO-POST FLAT SUPPORT ASSEMBLY

STEP 1

Attach flat posts I-Beam to foundation (project dependent, see foundation manual) or install in ground.

STEP 2

Bolt adjustable plate to I-Beam post using 4 fasteners (keep all bolts loose for adjustment).

STEP 3

Bolt north-south beam to adjustable plate using 4 fasteners, as per Figure 4 (keep all bolts loose for adjustment).

STEP 4

Fasten the brace to the brace bracket and to the north-south beam using 3 fasteners.

STEP 5

Repeat steps 1 through 4 for entire table.

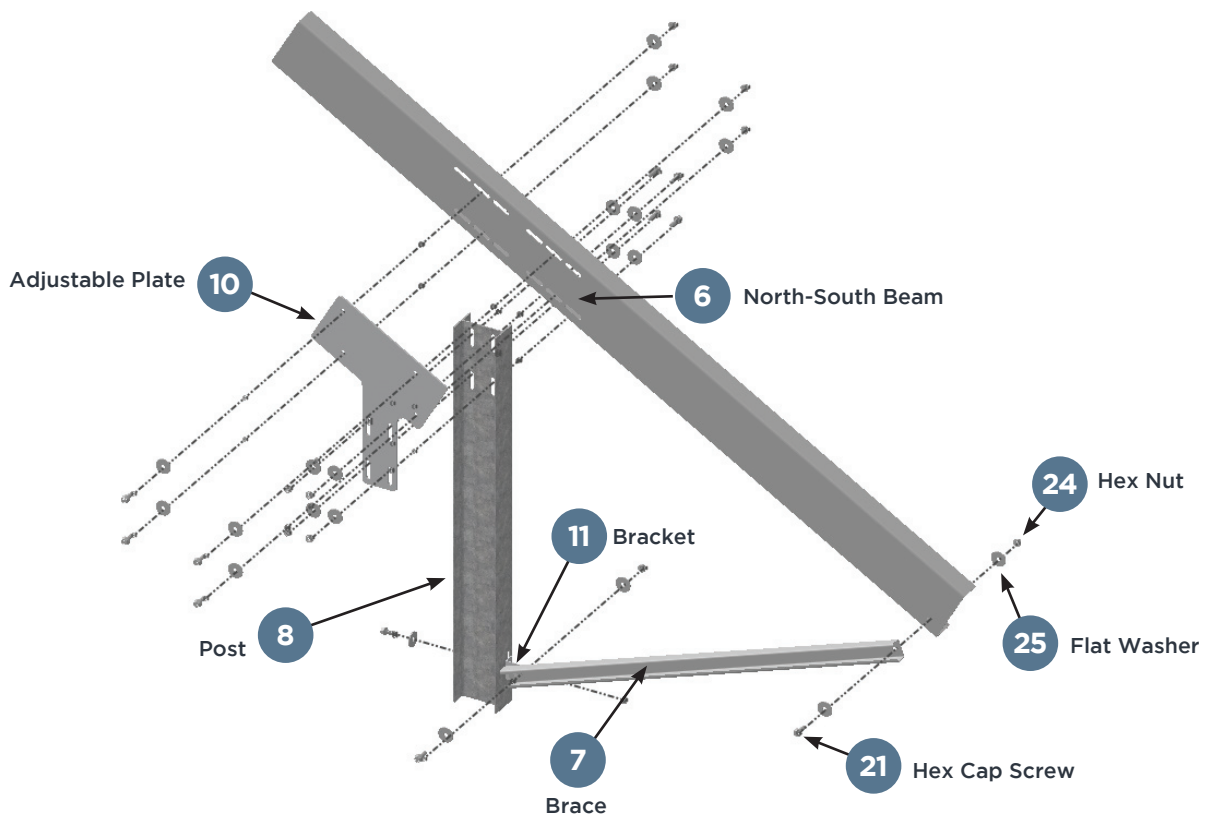


FIGURE 4: MONO-POST FLAT SUPPORT ASSEMBLY

Note: Ensure to torque fasteners according to torque tables specified in engineering drawings provided.

7. MONO-POST ROUND SUPPORT ASSEMBLY

STEP 1

Attach round posts to foundation (project dependent, see foundation manual).

STEP 2

Connect adjustable plate to post using 2 U-bolts (see engineering drawing) as shown in Figure 5 (keep all bolts loose for adjustment).

STEP 3

Bolt north-south beam to adjustable plate using 4 fasteners as shown in Figure 5 (keep all bolts loose for adjustment).

STEP 4

Join the end of the brace with 1 fastener to the north-south beam. The opening of this C-Channel should point west.

STEP 5

Attach the other end of the brace with the bracket using 1 fastener.

STEP 6

Fasten the bracket to the round post using 1 U-bolt.

STEP 7

Repeat steps 1 through 6 for entire table.

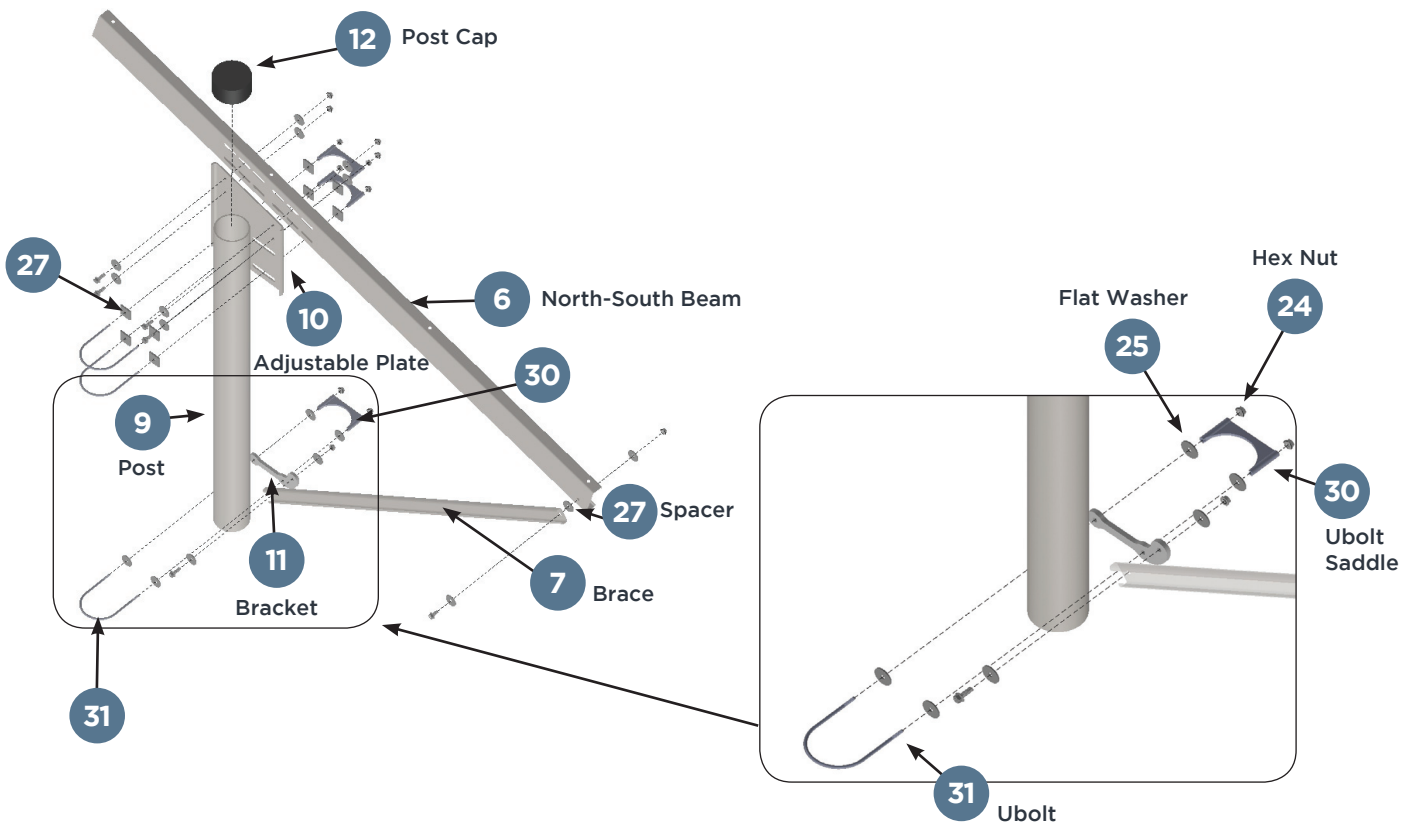


FIGURE 5: MONO-POST ROUND SUPPORT ASSEMBLY

Note: Ensure to torque fasteners according to torque tables specified in engineering drawings provided.

8. PURLIN INSTALLATION INSTRUCTIONS

A. PORTRAIT CONFIGURATION

Position east-west beams across top of north-south beams and attach with fasteners provided. For portrait configuration there are 2 east-west beams that support each row of PV panels. According to the engineering drawings provided for different lengths of PV tables, multiple east-west beams may need to be connected using a splice and 4 fasteners as shown in Figure 6.

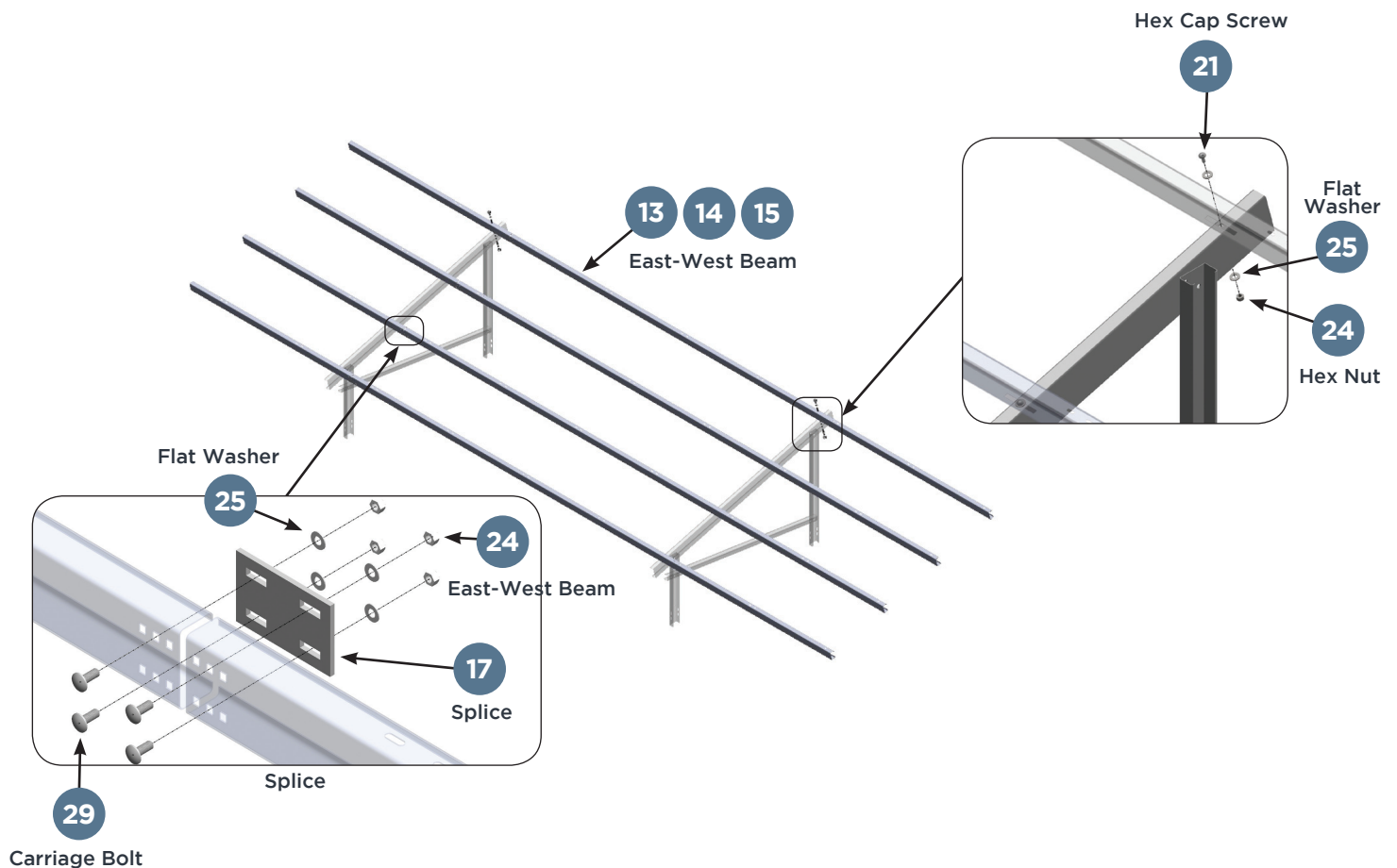


FIGURE 6: PURLIN ASSEMBLY (PORTRAIT CONFIGURATION)

Note: Ensure to torque fasteners according to torque tables specified in engineering drawings provided.

8. PURLIN INSTALLATION INSTRUCTIONS CONT'D

B. LANDSCAPE CONFIGURATION

STEP 1

Position east-west beams across top of north-south beams and attach with fasteners provided as shown in Figure 7. For landscape configuration there are 2 east-west beams for an entire PV table. According to the engineering drawings provided for different lengths of PV tables, multiple east-west beams may need to be connected using a splice and 4 fasteners (splice shown in Figure 6).

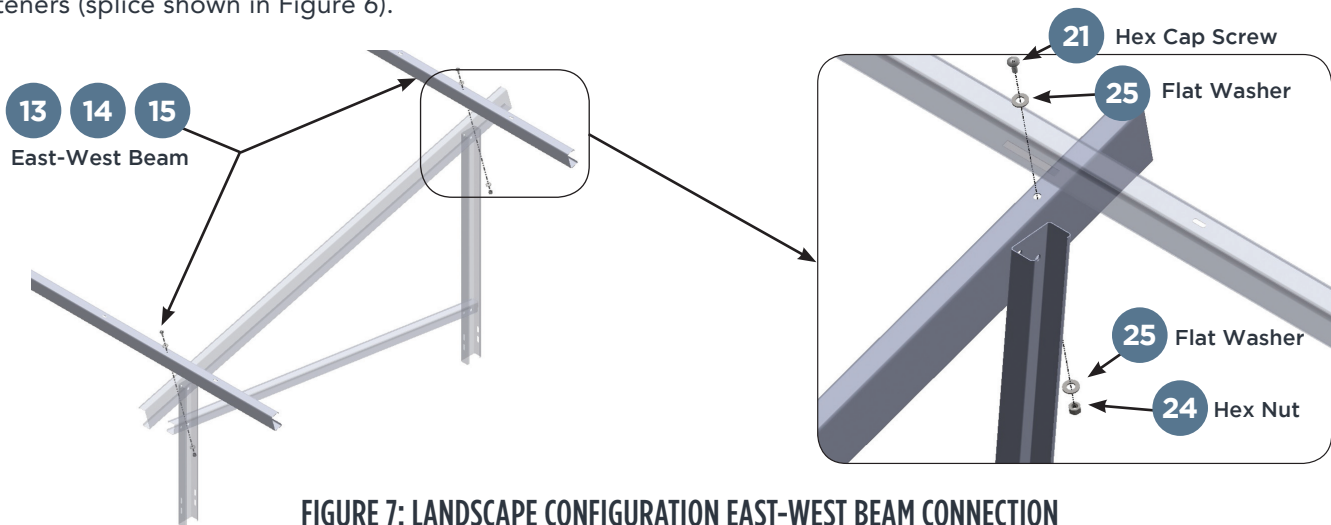


FIGURE 7: LANDSCAPE CONFIGURATION EAST-WEST BEAM CONNECTION

STEP 2

Attach north-south rails to east-west beams using 2 fasteners as shown in Figure 8. Opening of north-south rail C-Channels should point west.

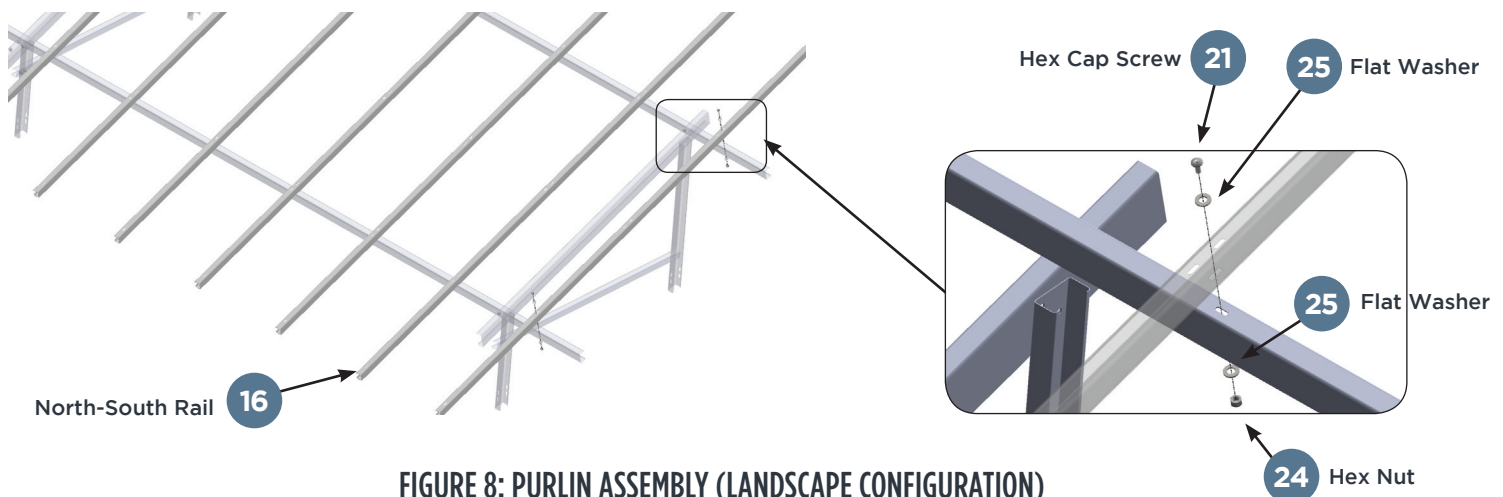


FIGURE 8: PURLIN ASSEMBLY (LANDSCAPE CONFIGURATION)

Note: Ensure to torque fasteners according to torque tables specified in engineering drawings provided.

9. FOOT BRACKET CONNECTION ASSEMBLY INSTRUCTIONS

Foot brackets can be used with helical piles, ground screws, pre-casted ballast, and micro-pile foundations.

STEP 1

Connect one foot bracket to each foundation pier plate. The side holes must be aligned along north-south plane. These are attached through arc slots using 4 fasteners as shown in Figure 9.

STEP 2

Slide each leg on top of a foot bracket, with the open section of the leg C-Channel oriented to west. Adjust as required. Bolt each leg to foot bracket side holes using 4 fasteners.

ADJUSTABILITY TOLERANCES

Height: $\pm 1''$
E-W: $\pm 2''$
N-S: $\pm 2''$
Tilt: $\pm 2^\circ$

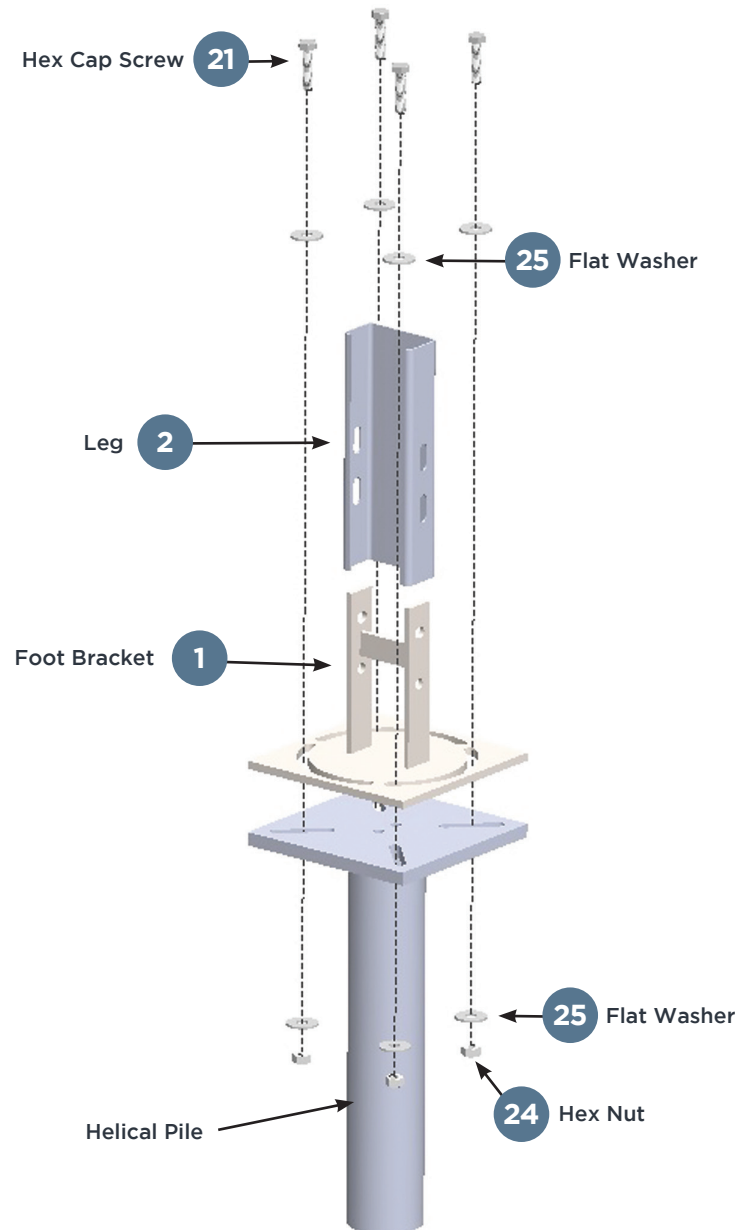


FIGURE 9: FOOT BRACKET CONNECTION ASSEMBLY

*Foundation piers are not included.

Note: Ensure to torque fasteners according to torque tables specified in engineering drawings provided.

10. PV MODULE INSTALLATION

Polar Racking offers 3 solutions for PV module attachment: clamping, direct bolting, and pre-populated module assembly.

A. CLAMPING INSTRUCTIONS

There are 2 mid-clamps that space and affix two adjacent panels (total of 4 clamps for each panel). There are two end-clamps per panel that affix the panel at the outside edges of a table.

STEP 1

Begin by installing the southwestern panel. Using 2 end-clamps, fasten the panel to the first and second east-west beams (portrait) or north-south rails (landscape). The top of the end clamp grips the frame of the PV panel and the bottom is bolted to the beam.

STEP 2

Attach 2 mid-clamps to the eastern side of the panel on the first and second east-west beams (portrait) or the northern end of the panel along the north-south rail (landscape). Do not complete torquing of these mid-clamps at this point. Each mid-clamp is secured to panels using 1 fastener as per Figure 10 (portrait configuration) or Figure 11 (landscape configuration) and engineering drawing provided.

STEP 3

Continue installing panels in the same manner from south to north of the first column. Use a spacer provided to create a uniform gap (project dependent) between rows (portrait) or columns (landscape).

STEP 4

Proceed to the second column, repeating the same procedure as in the previous steps. Finish torquing mid clamps once 2 panels are connected by two midclamps. Repeat the previous steps for the remainder of panels in the table. Use end-clamps in all locations where there is no adjacent panel.

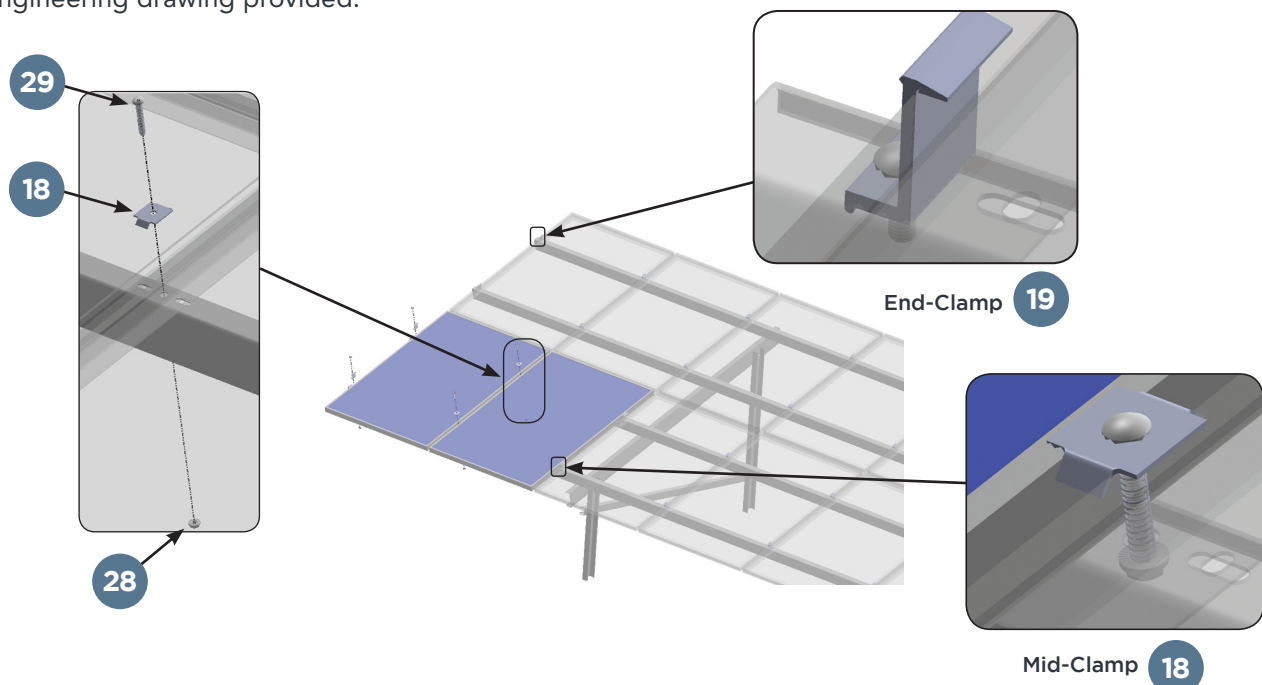


FIGURE 10: PORTRAIT CONFIGURATION CLAMPING

Note: Ensure to torque fasteners according to torque tables specified in engineering drawings provided.

10. PV MODULE INSTALLATION CONT'D

Polar Racking offers 3 solutions for PV module attachment: clamping, direct bolting, and pre-populated module assembly.

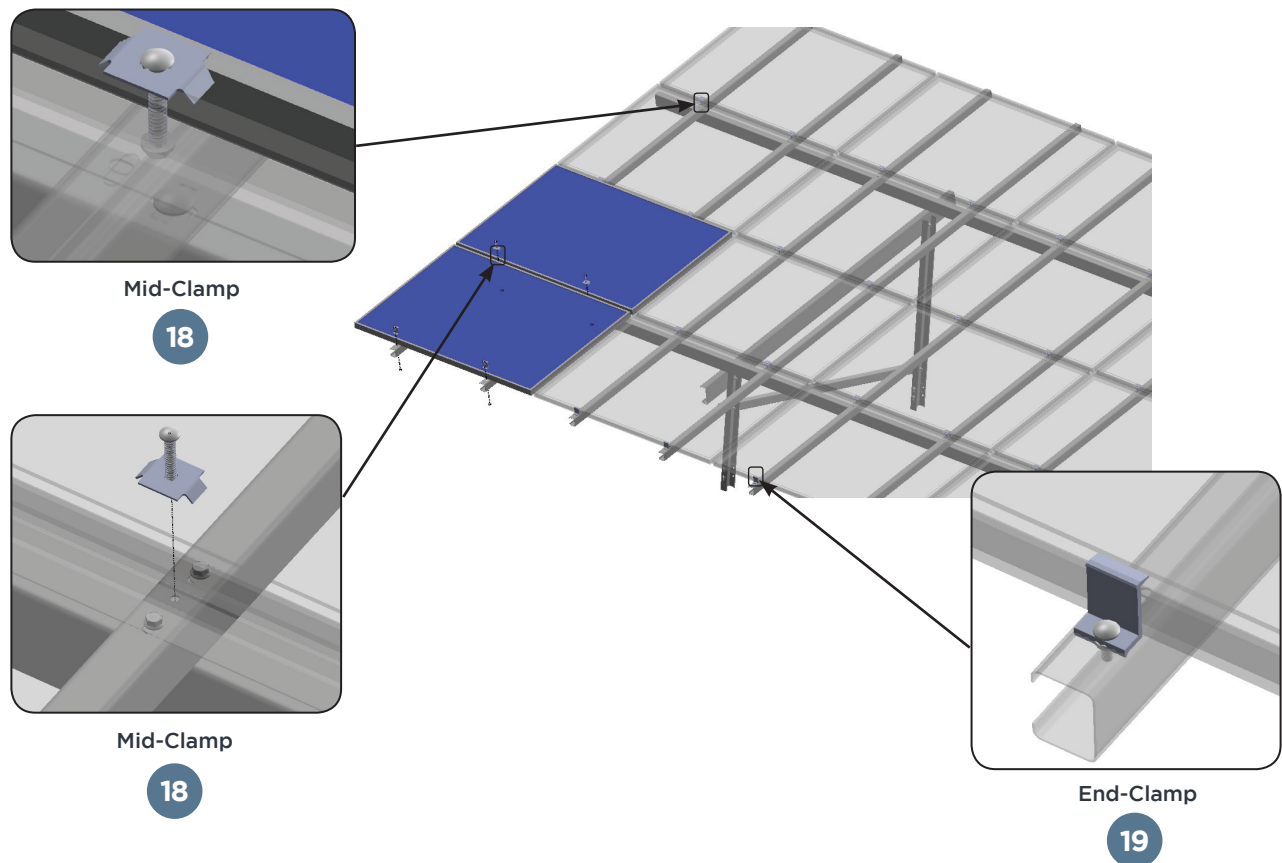


FIGURE 11: LANDSCAPE CONFIGURATION CLAMPING

Note: Ensure to torque fasteners according to torque tables specified in engineering drawings provided.

B. BOLTING INSTRUCTIONS

Begin by installing the southwestern panel. Bolt the panel directly to the 1st and 2nd east-west beams (portrait) or north-south rails (landscape) using 4 fasteners through the holes in east-west beams (portrait) or in north-south rails (landscape). Continue bolting panels in the same way, moving north until the end of the column. Continue with the next columns until the end of the table.

10. PV MODULE INSTALLATION CONT'D

Polar Racking offers 3 solutions for PV module attachment: clamping, direct bolting, and pre-populated module assembly.

C. PRE-POPULATED MODULE ASSEMBLY

Please follow the instructions on drawing titled Prepanelized Module Installation Instruction Drawing for assembly.

STEP 1

Use a forklift to unload the skids of prepopulated panels close to site.

STEP 2

Attach the lifting slings to lifting lugs of the polar installation apparatus

STEP 3

Lift and position modules on existing support assembly racking as required. Secure all prepanelized modules (as per engineering drawings).

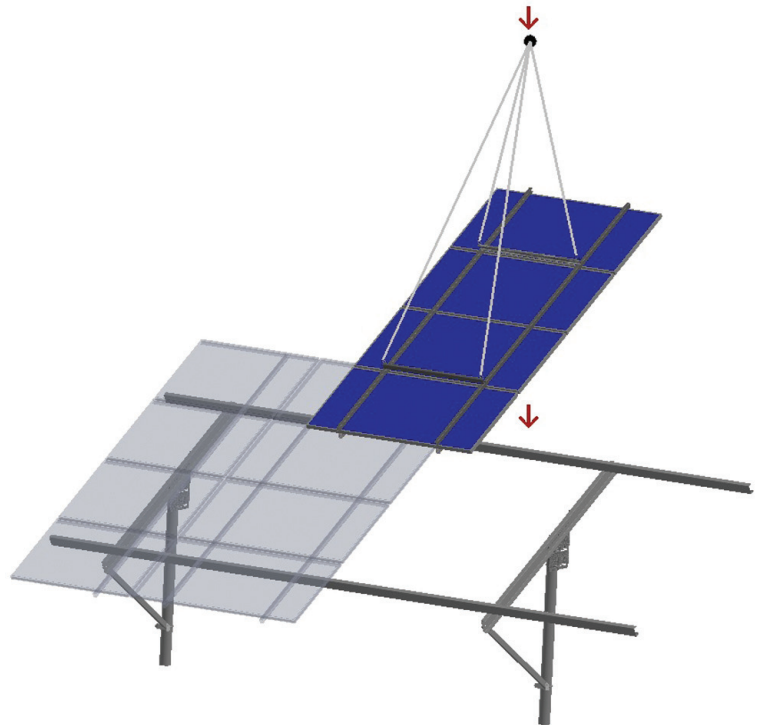


FIGURE 12: PREPANELIZED ASSEMBLY ONTO RACKING

Note: Ensure to torque fasteners according to torque tables specified in engineering drawings provided.

11. DUAL-POST FLAT SUPPORT ASSEMBLY

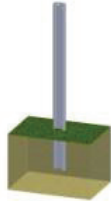

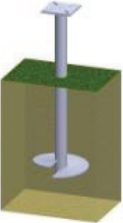




STEP 1

An optional jig similar to ones shown in Figure 1 to assemble leg support can be constructed. Polar can provide jig construction drawings at an additional cost. While constructing jig, consider that it will hold the south and north legs along the same plane (with open section of C-Channel facing down), the brace (with open section of C-Channel oriented up), and a north-south beam (with open section of C-Channel oriented up, along same plane as brace).

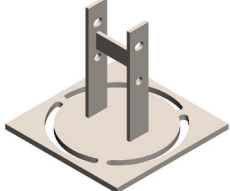
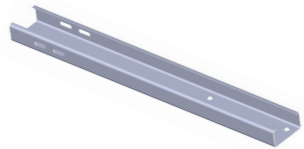
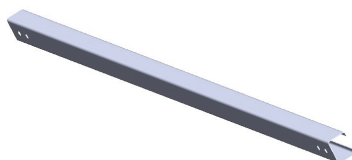
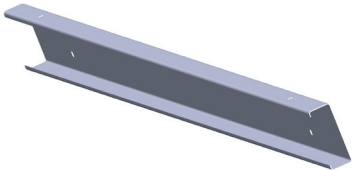
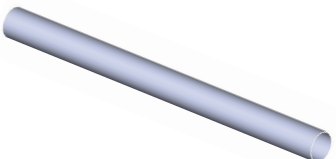


FIGURE 1: EXAMPLES OF JIG CONSTRUCTION





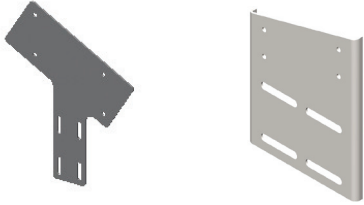


12. APPENDICES

APPENDIX A	FOUNDATION OPTIONS
<p>Driven post <i>I Beam or Round Post</i></p>	
<p>Grouted Post <i>I Beam or Round Post</i></p>	
<p>Helical Pier</p>	
<p>Ground Screw</p>	
<p>Post With Base Plate</p>	
<p>Pre-Cast Ballasts</p>	
<p>Pour-In Place Ballasts</p>	

DUAL-POST ASSEMBLY

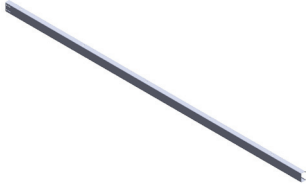
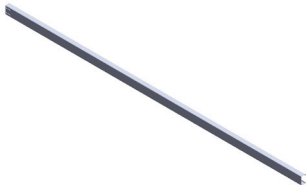
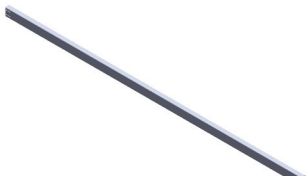

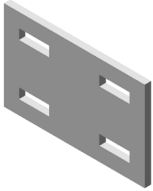
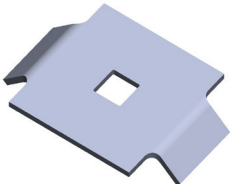
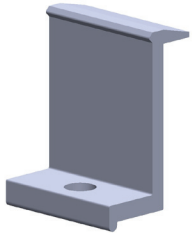
1	FOOT BRACKETS	
2	LEG, SOUTH & NORTH	PROFILE: C 
3	BRACE	PROFILE: C 
4	BEAM, NORTH-SOUTH	PROFILE: C 
5	NORTH POST SOUTH POST	





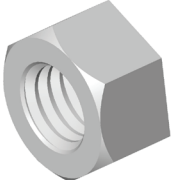


MONO-POST ASSEMBLY


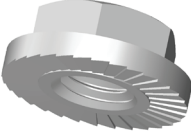
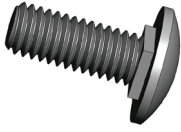
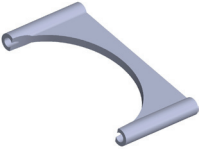

6	MONO-POST NORTH SOUTH BEAM	
7	MONO POST BRACE	
8	FLAT MONO-POST	
9	ROUND MONO-POST	
10	ADJUSTABLE PLATE	
11	BRACKET	
12	POST CAP	

APPENDIX B	PARTS LIST
------------	------------

PV ASSEMBLY

13	BEAM, EAST	C PROFILE 
14	BEAM, CENTER	C PROFILE 
15	BEAM, WEST	C PROFILE 
16	NORTH, SOUTH RAIL	C PROFILE 
17	SPLICE	
18	MID-CLAMP	
19	END-CLAMP	

	APPENDIX B	PARTS LIST
	HARDWARE	
20	SCREW, SOCKET HEAD	
21	CAP SCREW, HEX HEAD	
22	CAP SCREW, HEX FLANGE	
23	NUT, HEX FLANGE	
24	NUT, HEX	
25	WASHER, FLAT	
26	THREAD CUTTING SCREW, INDENTED HEX WASHER HEAD	

APPENDIX B		PARTS LIST
HARDWARE		
27	SQUARE WASHER	
28	HEX FLANGE NUT SERRATED	
29	CARRIAGE BOLT	
30	UBOLT SADDLE	
31	UBOLT	

12. WARRANTY

Polar Racking Inc. ("Polar"), warrants to the original purchaser ("Purchaser") of its racking Product(s) ("Product") that the Product shall be free from defects in material and workmanship for a period of ten (10) years from the date of original purchase ("Racking Warranty"), save and except for the finish of said Product.

WHAT DOES THE WARRANTY COVER?

The Racking Warranty covers any defects in material and workmanship, but does not include on-site labour.

HOW LONG DOES THE COVERAGE LAST?

The Racking Warranty lasts for a period of ten (10) years from the date of original purchase. The warranty, during its term, is transferable from the Purchaser to a new owner of the Product upon written notice of said change of ownership being given from the original purchase to Polar within 60 days of said change of ownership.

WHAT WILL POLAR DO?

If within the specified Warranty periods the Product shall be reasonably proven to be defective, then Polar shall at its option, and subject to the limitations described herein, Polar will: (i) repair or replace any defective Product at no charge; (ii) refund the full purchase price of the Product; or (iii) issue credit in the amount of the purchase to be used toward the purchase of new Product or accessories from Polar. Such repair or replacement shall completely satisfy and discharge all of Polar's liability with respect to this limited Warranty.

WHAT DOES THIS WARRANTY NOT COVER?

The following are not covered by these warranties: on-site labour in any form and any problem or damage that is caused by abuse; negligence; failure to follow professional engineer stamped drawings for the specific installation; normal wear and tear; defective roofing; modifications or repairs not performed or authorized by Polar; overloading; misuse, including but not limited to failure to assemble, mount, or use the Product in accordance with its written instructions or guidelines included with the Product or made available to the Purchaser; or an act of God (such as wind storms or similar events). Polar is not liable for or warranty material used on or fixed to the bottom of Product, which in all installations are chosen by the original purchaser/ installer/ user of the Product. All installations in corrosive atmospheric conditions are excluded and void said Racking Warranty. This Racking Warranty shall be Void if installation of the Product is not performed in accordance with any Professional Engineer stamped drawings created for the specific installation, or Polar's written installation instructions, or if the Product has been modified, repaired, or reworked in a manner not previously authorized in writing by Polar, or if the Product is installed in an environment of fashion for which it was not designed.

The Racking Warranty does not cover damage to the Product that occurs during its shipment, storage, or installation.

No warranty is given for Products purchased or used outside the United States, Canada, or Mexico. To the furthest extent permitted by law, (i) this warranty does not cover damage to property other than the Product itself; and (ii) the remedies provided for herein shall be exclusive.

POLAR LIMITS THE DURATION OF ALL IMPLIED WARRANTIES, INCLUDING BUT NOT LIMITED TO ANY WARRANTY OF MERCHANTABILITY OR FITNESS FOR PARTICULAR PURPOSE TO THE SHORTEST PERIOD PERMITTED BY LAW, WHICH IN ANY EVENT SHALL NOT EXCEED THE DURATION OF THIS WARRANTY. Some provinces/ states do not allow limitations on how long an implied warranty lasts, so the above limitation may not apply to you. ALSO, CONSEQUENTIAL AND INCIDENTAL DAMAGES ARE NOT RECOVERABLE UNDER THIS WARRANTY. Under no circumstances shall Polar be liable for special, indirect or consequential damages arising out of or related to use by Purchaser of the Product. Manufacturers of related items. Some provinces/ states do not allow the exclusion or limitation of incidental or consequential damages, so the above limitation or exclusion may not apply to you.

Polar will not be held responsible for any modification or alterations made to any approved design layout and/ or specification provided by Polar. Any and all proposed changes must first be reviewed, and approved in writing by Polar's Engineering team. No warranty is provided or implied by Polar with regards to longevity or leak-resistance of the roof, validity of any roof warranty, ballasting or anchoring of the Product, suitability of the roof to support the installation of such Product, or otherwise. By acceptance of this document, the Purchaser acknowledges that they understand and agree to/ with the above statement and any and all limitations detailed in this warranty.

HOW DO YOU GET SERVICE?

In order to be eligible for service under this warranty you must immediately notify Polar, in writing, upon learning of any defect of its Products by either calling the phone number listed above or writing to the address listed above and explaining the nature of defect. If appropriate, arrangement for service under this warranty will be made. You may be required to provide proof of purchase prior to obtaining service under this warranty. In addition, Polar may require you to return the Product to Polar, in its sole discretion, as to whether the Product is defective.

IMPORTANT WARNING

It is critical that the Polar Racking be properly and securely attached together and installed on a roof. Improper installation could result in injury or damage to people and property including, but not limited to, the installer(s), building, roof, solar modules and other people and equipment. You are responsible for installing and securing the Polar Racking system properly and checking the attachments prior to module installation.

Read and understand all of the instructions and cautions supplied with your Polar Racking Product prior to installation or use. If you do not understand all of the instructions and cautions, or if you do not have sufficient mechanical and electrical experience and are not thoroughly familiar with the installation procedures, you should have the Product installed by a professional installer.



11 KODIAK CRESCENT, SUITE C | TORONTO, ONTARIO M3J 3E5
416-860-6722 | INFO@POLARRACKING.COM | WWW.POLARRACKING.COM